

Sizes 14" thru 24" / 350mm thru 600mm
Gear Box - Buried Service

Materials

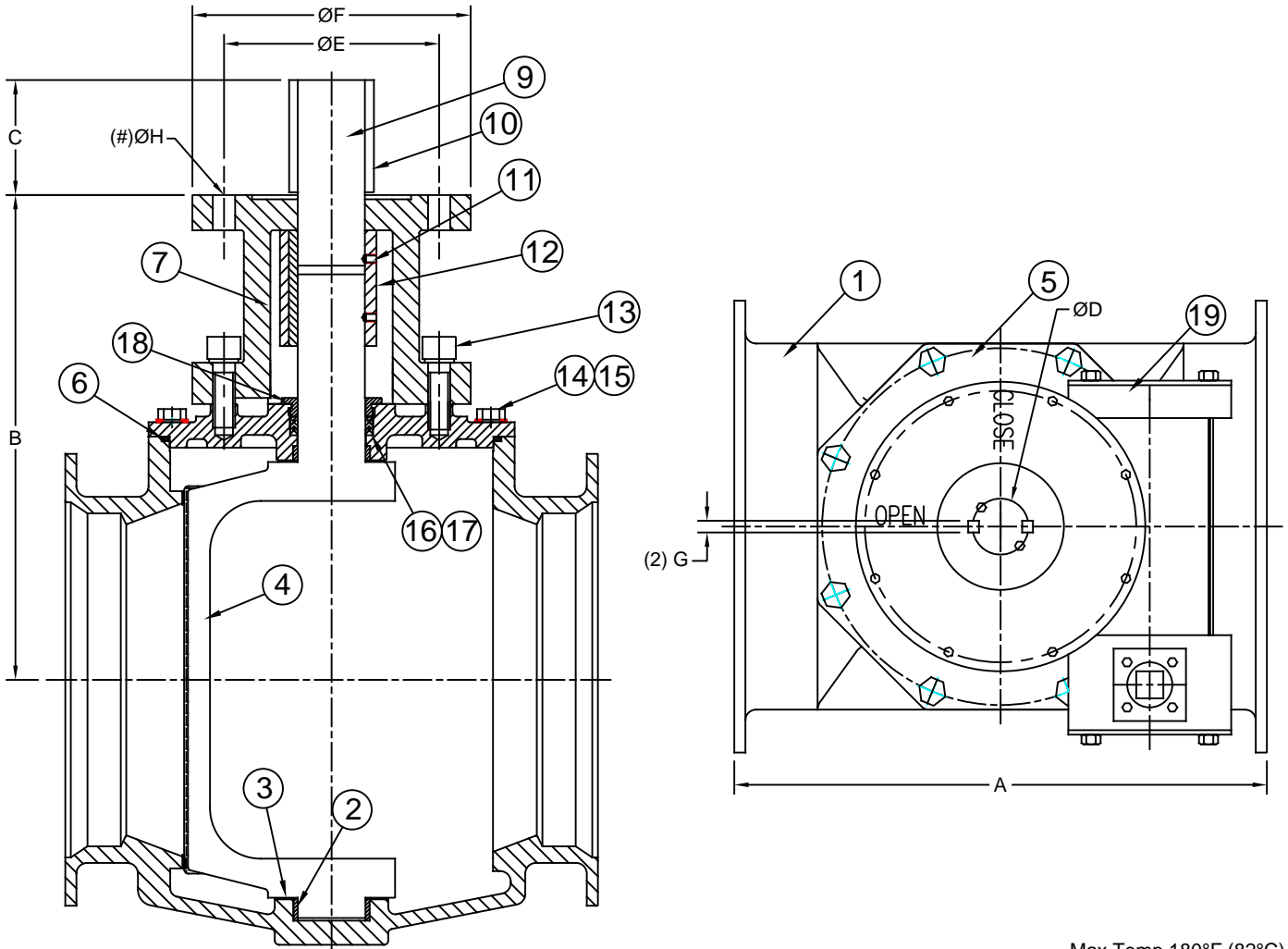

Max Temp 180°F (82°C)
Max Pressure 200psi (14bar)

Item #	Qty	Description	Material	ASTM	Item #	Qty	Description	Material	ASTM
1	1	Body	Ductile Iron	A536 (65-45-12)	11	2	Bolt	Carbon Steel	A307B
2	2	Bushing	Stainless Steel	316	12	1	Bushing	Carbon Steel	1450
3	2	Washer	Copper	C12700	13	A/R	Bolt	Carbon Steel	A307B
4	1	Plug	Ductile Iron/EPDM	A536 (65-45-12)	14	A/R	Bolt	Carbon Steel	A307B
5	1	Cover	Ductile Iron	A536 (65-45-12)	15	A/R	Washer	Carbon Steel	A570
6	1	O-Ring	NBR	-----	16	4	V-Packing	NBR	-----
7	1	Key	Carbon Steel	1450	17	1	Pad	Brass	C2800
8	1	Shelf	Ductile Iron	A536 (65-45-12)	18	1	Gland	Carbon Steel	1450
9	1	Extended Shaft	Carbon Steel	1450	19	1	Gear Box	Ductile Iron	A536 (65-45-12)
10	2	Key	Carbon Steel	1450					

MANUFACTURED IN COMPLIANCE WITH AWWA C517 STANDARD

Flomatic Corporation can accept no responsibility for possible errors in catalogues, brochures and other printed material. Flomatic Corporation reserves the right to alter its products without notices. This also applies to product already agreed. All trademarks in this material are property of the respective companies. All right reserved. ©2019 Flomatic Corporation. The drawings & information on this drawing sheet are the sole & exclusive property of Flomatic Corporation. Any reproduction, distribution, display or use of these drawings or information in whole or in part without written authorization of Flomatic Corporation is strictly prohibited. www.flomatic.com

Dimensions (Mechanical Joint ANSI/AWWA C111/A21.11 flanges)

Valve Size		Part #	A		B		C		ØD		ØE		ØF	
inch	mm		inch	mm	inch	mm	inch	mm	inch	mm	inch	mm	inch	mm
14	350	5430000147	24.50	622	21.10	536	3.35	85	1.22	66	10.00	254	11.81	300
16	400	5430000167	24.25	692	22.75	578	3.35	85	1.22	66	10.00	254	11.81	300
18	450	5430000187	29.25	743	24.25	616	3.35	85	1.22	66	10.00	254	11.81	300
20	500	5430000207	30.91	787	28.31	719	5.04	128	3.94	100	14.00	356	16.34	415
24	600	5430000247	42.00	1067	28.62	727	5.31	135	3.94	100	14.00	356	16.34	415

Valve Size		Part #	G		(#) ØH			Gearbox # of turns to close	Gearbox Ratio	Weight	
inch	mm		inch	mm	#	inch	mm			lbs	kg
14	350	5430000147	.79	20	8	.71	18	217	821:1	573	260
16	400	5430000167	.79	20	8	.71	18	217	821:1	661	300
18	450	5430000187	.79	20	8	.71	18	217	821:1	882	400
20	500	5430000207	1.10	28	12	.91	23	285	1102.1	1370	620
24	600	5430000247	1.10	28	12	.91	23	285	1102.1	2271	1030

MANUFACTURED IN COMPLIANCE WITH AWWA C517 STANDARD

Flomatic Corporation can accept no responsibility for possible errors in catalogues, brochures and other printed material. Flomatic Corporation reserves the right to alter its products without notices. This also applies to product already agreed. All trademarks in this material are property of the respective companies. All right reserved. ©2019 Flomatic Corporation. The drawings & information on this drawing sheet are the sole & exclusive property of Flomatic Corporation. Any reproduction, distribution, display or use of these drawings or information in whole or in part without written authorization of Flomatic Corporation is strictly prohibited. www.flomatic.com