

Materials

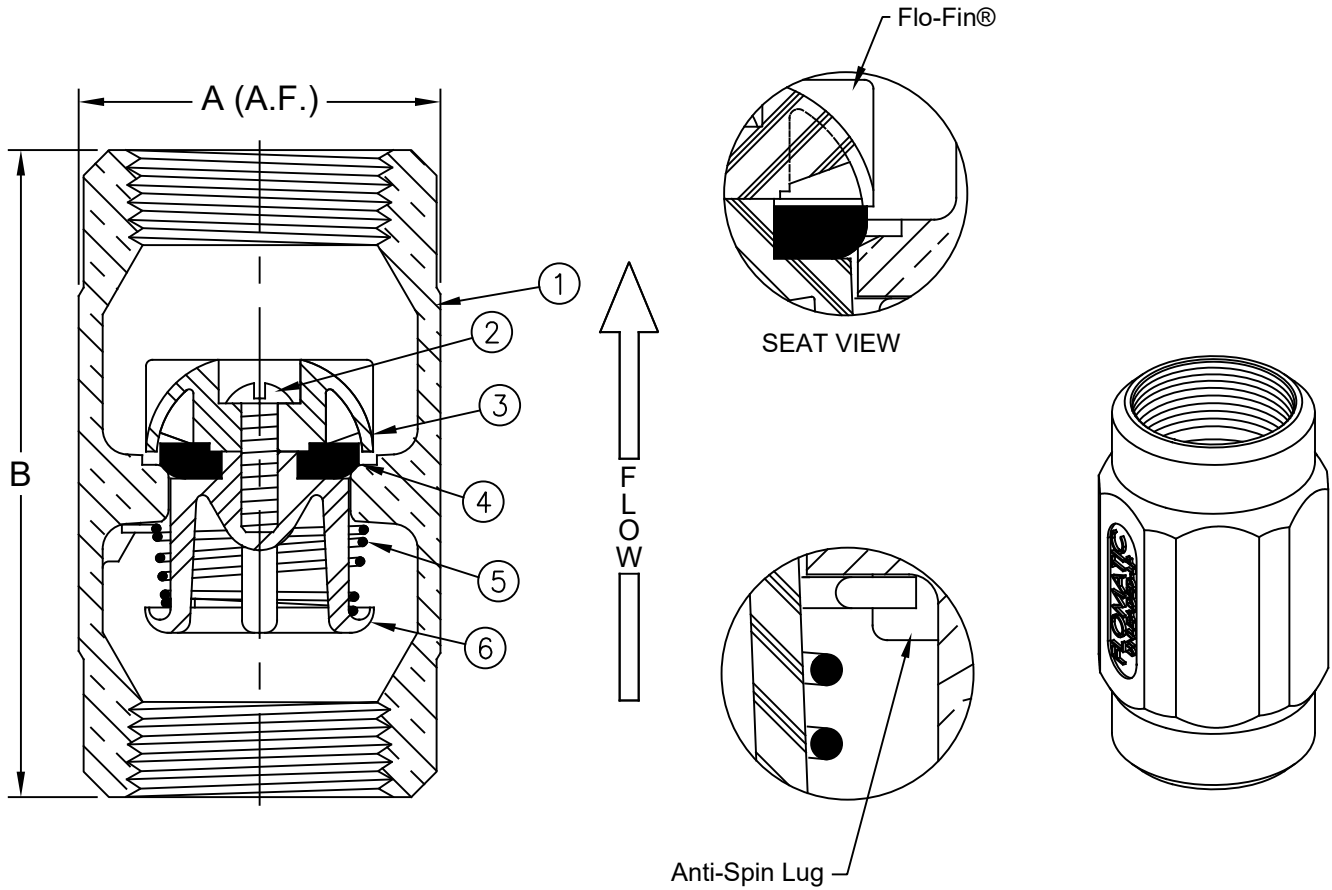

Temp Max: 180°F (82°C)
Pressure Max: 400 psi (28bar)

Item #	Qty	Description	Material	ASTM
1	1	Body	Unleaded Bronze	C89833
2	1	Screw	Stainless Steel	302
3	1	Dome	Delrin	500P
4	1	Disc	Buna-n	N-5007
5	1	Spring	Stainless Steel	302
6	1	Guide*	Delrin	500P

*1" Guide uses Celcon® GC10

Dimensions (FNPT X FNPT)

ANSI B1.20.1

Patent #'s 4,971,093 & 6,581,633

Size		Part #	A		B		Weight	
inch	mm		inch	mm	inch	mm	lbs	kg
1	25	4201E	1-25/32	45	3-21/32	93	1.35	.62
1-1/4	32	4202E	2-1/8	54	3-15/16	100	1.75	.79

Flomatic Corporation can accept no responsibility for possible errors in catalogues, brochures and other printed material. Flomatic Corporation reserves the right to alter its products without notices. This also applies to product already agreed. All trademarks in this material are property of the respective companies. All rights reserved. ©2024 Flomatic Corporation. The drawings & information on this drawing sheet are the sole & exclusive property of Flomatic Corporation. Any reproduction, distribution, display or use of these drawings or information in whole or in part without written authorization of Flomatic Corporation is strictly prohibited. www.flomatic.com